

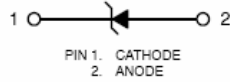

ESDQR5V0U

5V Uni-directional ESD



Features

- Meet IEC61000-4-2 (ESD)±15kV (air),±8kV (contact)
- Meet IEC61000-4-4 (EFT) rating. 40A (5/50µs)
- Protects single I/O lines
- Working Voltage : 5V
- Low leakage current
- Low operating and clamping voltages
- Pb free version, RoHS compliant, and Halogen free

Mechanical Characteristics

- Case: DFN1006(0402) mold package
- Terminal: Sn/Au plated, solderable per MIL-STD-750, method 2026
- Mounting position: Any
- Marking Code: Cathode band & 5U
- Weight: 0.001 gram(approx.).
- MSL: Level 1

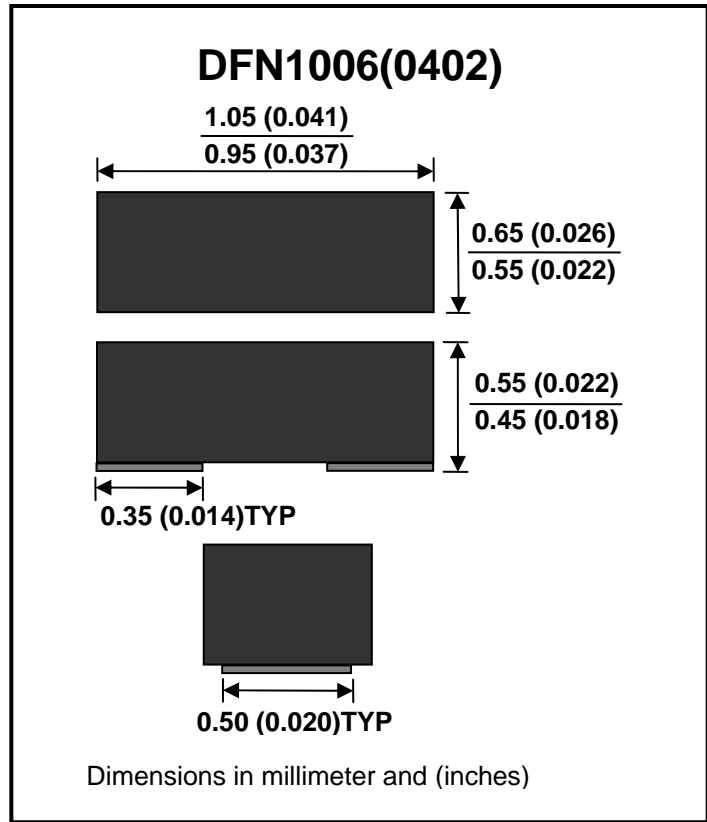

Maximum Rating And Electrical Characteristics (at Ta=25°C unless otherwise noted)

Parameter	Condition	Symbol	Min	Typ	Max	Unit
Peak Pulse Power	tp=8/20 µs (According to IEC61000-4-5)	PpK		135		W
Maximum Peak Pulse Current	tp=8/20us (According to IEC61000-4-5)	Ipp		10		A
ESD per IEC 61000-4-2 (Air)		Vpp		±15		kV
ESD per IEC 61000-4-2 (Contact)				±8		kV
Operating Junction Temperature		Tj	-55		125	°C
Storage Temperature		Tstg	-55		150	°C
Reverse Stand-Off Voltage		VRWM			5	V
Reverse Breakdown Voltage	It = 1mA	VBR			7.6	V
Reverse Leakage Current	VRWM = 5V	IR			1	uA
Clamping Voltage	Ipp = 10A , tp = 8/20 µs	Vc			13.5	V
Junction Capacitance	VR=0V , f=1MHz	Cj			80	pF



Typical Characteristics

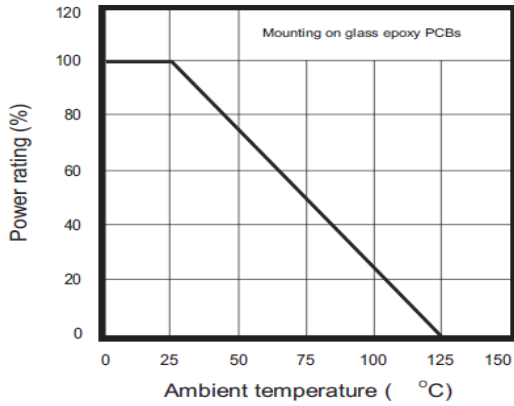

Fig 1 : Peak Plus Power VS Exponential Plus Duration

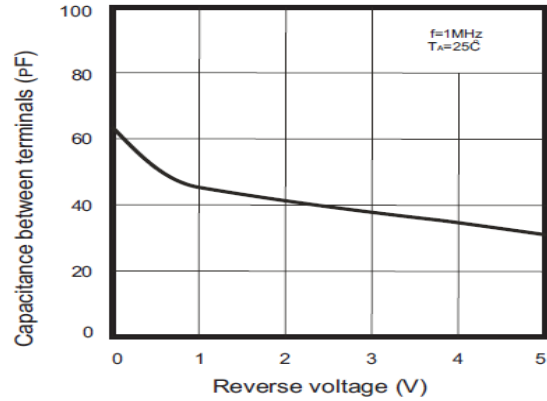

Fig 2 : Junction Capacitance Vs Reverse Voltage Applied

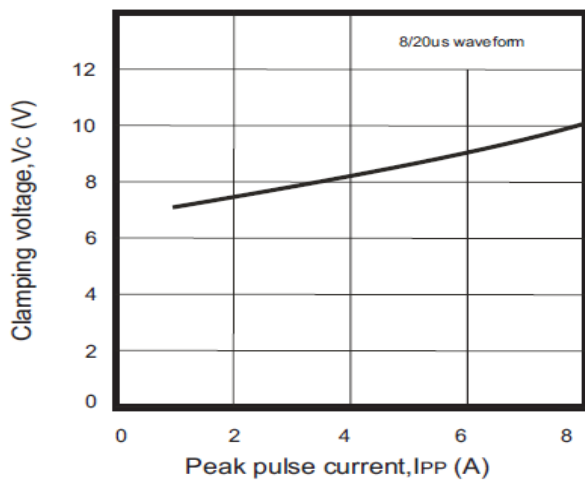

Fig 3 : Clamping Voltage VS Peak Pulse Current

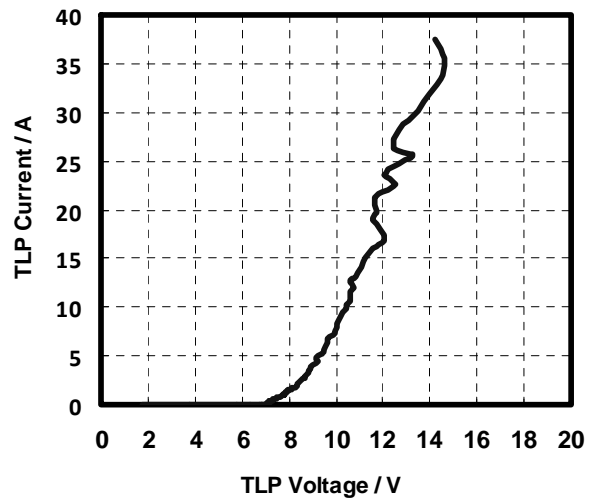
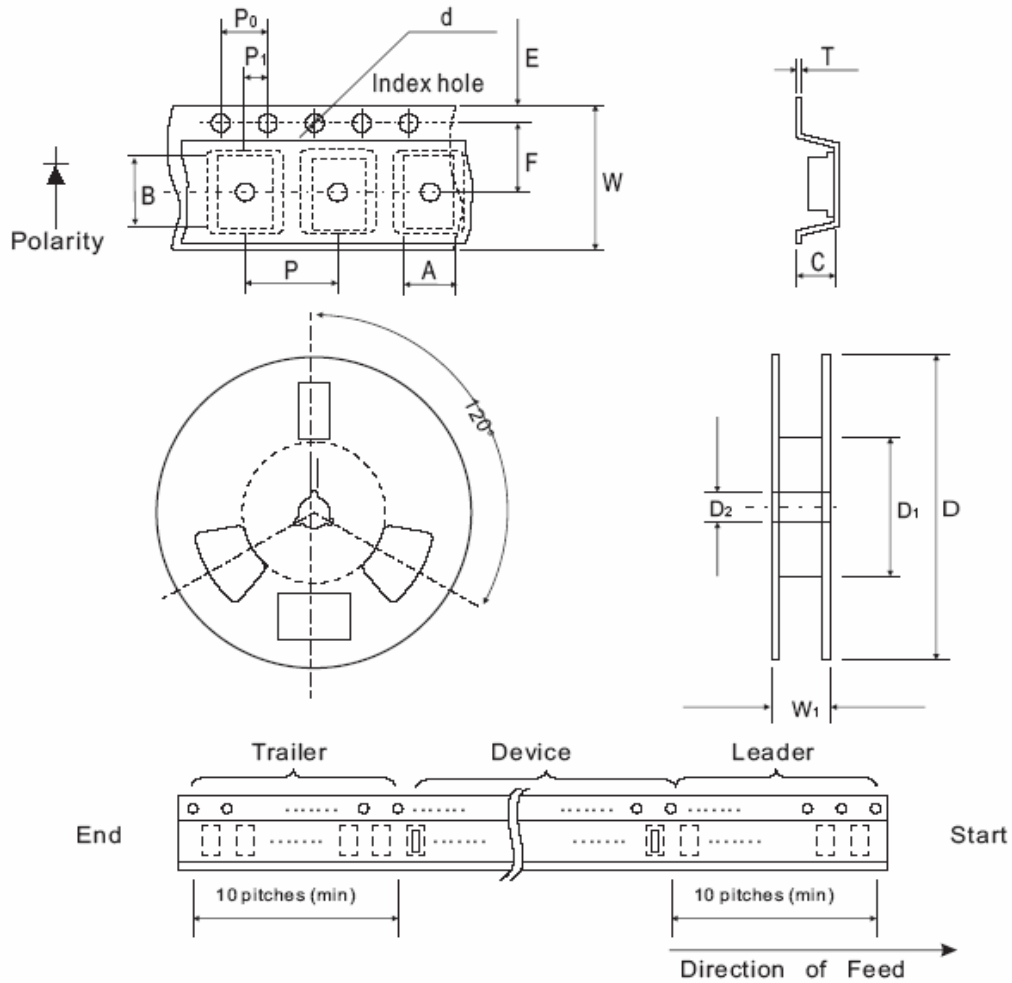

Fig 4 : TLP Measurement



ESD Diode

Packing Specification



Tape & Reel Dimensions

Package	Unit	A	B	C	d	D
DFN1006	mm	0.67±0.10	1.12±0.10	0.60±0.10	1.50±0.10	178±1
	inch	0.026±0.004	0.044±0.004	0.024±0.004	0.060±0.004	7.008±0.04

Package	Unit	D1	D2	E	F	P
DFN1006	mm	60MIN	13.0±0.20	1.75±0.10	3.5±0.10	4.0±0.10
	inch	2.362MIN	0.512±0.008	0.069±0.004	0.138±0.004	0.157±0.004

Package	Unit	P0	P1	T	W	W1
DFN1006	mm	4.0±0.10	2.0±0.10	0.22±0.03	8.0±0.10	10.5±0.5
	inch	0.157±0.004	0.079±0.004	0.009±0.002	0.315±0.004	0.413±0.02



ESD Diode

Standard Package

Package	Reel Size	Qty/Reel
DFN1006	7"	5,000 pcs

Recommended Soldering Footprint

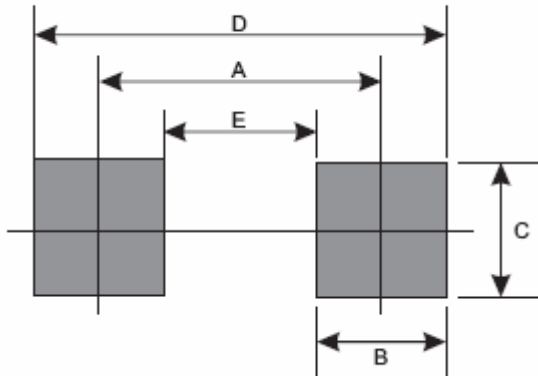

Reflow Soldering

Product Size	Dimension/ mm				
	A	B	C	D	E
DFN1006	0.750	0.500	0.700	1.250	0.250
	0.030"	0.020"	0.028"	0.049"	0.010"

Marking Code

Part Number	Marking Code
ESDQR5V0U	5U



Disclaimers

These products are not designed for use in applications where any failure or malfunction may result in personal injury, death or severe property or environmental damage such as medical, military, aircraft, space or life support equipments.